



UNITED BRASS WORKS, INC

714 S. Main St.. Randleman, N.C. 27317

Phone: 800/334-3035 Fax: 800/498-4696 www.ubw.com



Model 625 Quick Opening Flanged Blow-Off Valve Class 300 * ANSI B 16.34 * 650 psi Working Steam Pressure @ 500 F 750 psi @ 100 F * 100% Pressure Tested * Powder Coated Finish (Black)

Max Pressure for Boiler Blow Off 480 PSI

CRN OCO7135.2, 24, 25, 26

CRN OEO2171.7, 79, 70, 78, 7AY, 7T, 7N

The United Brass quick opening flanged boiler blow off valve has been designed for the rugged service of boiler treatment and scale. The cast steel knife gate valve conforms to Class 300 of ANSI B16.34 and features a stainless steel seat and disc hardened to Rockwell 60. ASME Boiler and Pressure Vessel Code Section 1 PG-42.1.12 and Power Piping Code ASME B 31.1 Table 126.1 reference steel valves to ANSI B 16.34. The sliding disc provides a "cleaning" action that keeps the seating area clear of scale and debris.

ITEM	DESCRIPTION	MATERIAL	QUANTITY
1	Stem	410 Stainless Steel	1
2	Packing	Graphite	1
3	Packing Nut	410 Stainless Steel	1
4	Stem Spring	17-7 Stainless Steel	1
5	Stem Rivet	Carbon Steel	1
6	Disc Arm	ASTM A216 WCC	1
7	Disc Spring	17-7 Stainless Steel	1
8	Disc Rivet	Carbon Steel	1
9	Gate Disc	440C Stainless Steel	1
10	Gasket	Tanged Graphite	1
11	Hex Nut	Grade 8	4 (1"-11/4") 5 (11/2") 6 (2")
12	Handle	Ductile Iron	1
13	Washer	Stainless Steel	1
14	Jam Nut	Stainless Steel	1
15	Hex Bolt	Grade 8	4 (1"-11/4") 5 (11/2") 6 (2")
16	Lock Washer	Grade 8	4 (1"-11/4") 5 (11/2") 6 (2")
17	Cover	ASTM A216 WCC	1
18	Body	ASTM A216 WCC	1

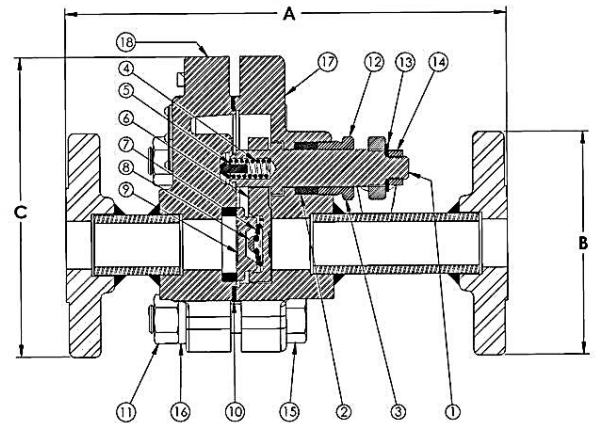

SIZE	1"	1 1/4"	1 1/2"	2"
A	9.70	9.70	10.90	12.60
B	4.90	5.25	6.10	6.50
C	6.80	7.0	8.28	9.80
D	2.50	2.50	3.20	1.90
B.C.	3.50	3.50	4.50	6.50
BOLT HOLES	4	4	4	8
Unit Wgt.	22.80	25.20	41.20	60.20

